



**KAINDL**

BOARDS. FLOORS. IDEAS.

# INSTALLATION INSTRUCTIONS



**This installation profile is for:**

Product group	Product	Plank Format	Thickness	Installation profile	Addition
CLASSIC TOUCH	Standard Plank	1383 x 193 mm	7	Angle / Angle	



**Installation profile**

Angle/ Angle

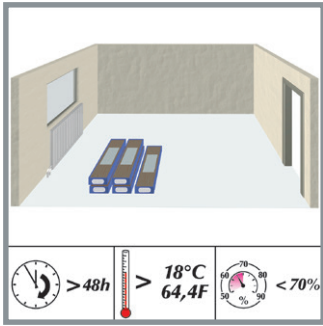

### Storage:

Store in the room/s which the product will be installed for a minimum of 48 hours Kaindl Laminate flooring should be stored in Moisture free, dry rooms. For During transportation it is necessary that the cartons and pallets are protected from the weather.

### Storage before installation:

The panels should be stored unopened in the middle of the room. Please store the unopened Kaindl Laminated Flooring packs at a room temperature of at least 18°C (64,4°F) and a relative humidity of ≤ 70% for minimum of 48 hours.

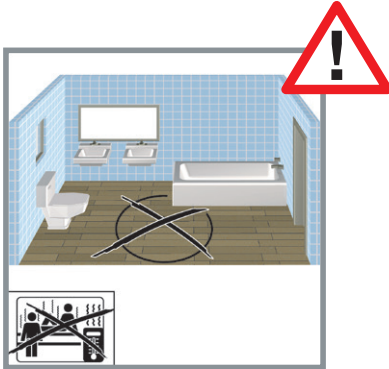

### Not suitable for wet areas

Laminate Flooring consists predominantly of wood. Continual and repetitive exposure to dampness causes irreparable damage to the laminate flooring.



### Raw material

The laminate flooring is manufactured exclusively from timber which is a product of domestic (A and D) forests managed on the basis of permanent sustainability. Raw materials are sourced from an area within approximately 500 km from the factory.

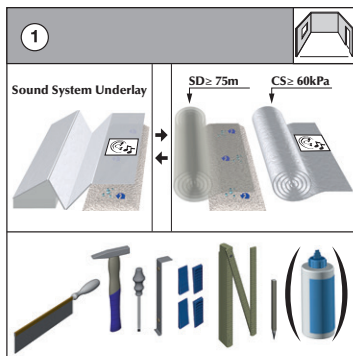

### Needed installation tools:

- Vapor barrier: Floor area +10%
- Sound underlayment: Floor area +5%, compressive strength (CS) > 90 kPa
- Saw
- Hammer: at least 500 gr.
- Pull Bar
- Spacer
- Measuring device
- Pencil

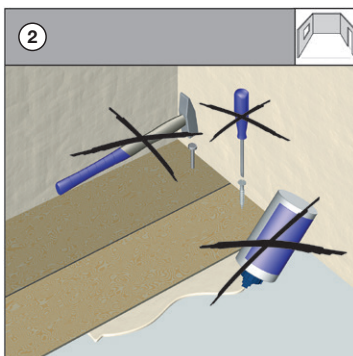

### It is prohibited to affix any part of the Laminate Flooring to the subfloor or any other object

The flooring should be laid without the use of any adhesives or other means of attachment - the tongue and groove are designed to mechanically locked together. Under no circumstances should the panels be glued, nailed, or otherwise affixed to the subfloor. NO heavy objects should be placed on top of the floor that would prohibit the floor from floating and expanding/contracting naturally, as it is designed to.

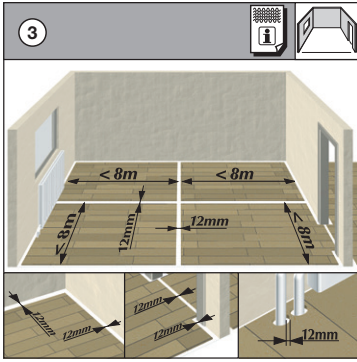

### Maximum span without expansion gap

The largest possible continuous installation area without transition is 8m (26') in the direction of the panel width and 8m (26') in the direction of the panel length.

Larger areas must be separated by expansion joints of at least 12 mm (1/2") . Laminate flooring consists largely of wood. Wood is a hygroscopic material and always adapts to the ambient humidity, which in turn results in a change in dimension.

The expansion can reach up to 2 mm/m (1/16" on 3'). This fact should be considered from a construction viewpoint when laying the flooring. A minimum distance of 12 mm (1/2") from the wall must be maintained around the perimeter. Expansion joints of at least 12 mm (1/2") must be provided between rooms. These expansion joints can be covered with special profiles. A distance of 12 mm (1/2") to fixed installations, e.g. radiators, must also be maintained.

[Download Info sheet 4 Expansion Joints](#)

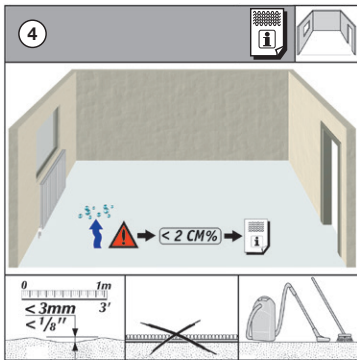

### Subfloor requirements

Dry, level, firm and clean sub floor.

#### Evenness

The sub-floor has to be even to a maximum of 3 mm/m (1/8" on 3'). Small differences in floor level can be adjusted with an underlay. Unevenness in floor level of more than a maximum of 3 mm/m (1/8" on 3') must either be sanded down or filled in with filling/leveling compound.

#### Existing Subfloors

Old fixed carpets, Needle felt carpets are unhygienic and too soft for installing laminate flooring over and must be removed. An installation on PVC and linoleum- coating can only be done-, if the floor is glued down and has no loose areas and if there is no underfloor heating.

#### Cleanness

The subfloor has to be absolutely clean before installing the laminate and free of any debris.

### Installation on concrete/mineral compound subfloor

As the duration of drying depends on climatic conditions, the stated drying periods are to be considered as guidelines. In any case, for safety purposes, two weeks should be added. Absolute certainty can only be guaranteed by adequate measuring e.g.

- CM method (calcium carbide method). Base Drying Period Remaining Humidity  
CM-concrete c.f.1 week/cm 2.0%
- anhydrate c.f. 2 weeks/cm 0,3%
- Poured asphalt from 18 supo/supC
- magnesia c.f. humidity balance
- mineral filler prod. instructions

### Installation on wood subfloors

Wooden constructions must be sufficiently ventilated (4cm<sup>2</sup>/sup\_ ventilation area per each m<sup>2</sup>/sup\_ of flooring). Principally sub-floors consisting of wood (chipboard, hardboard and floorboard etc.) must not be covered with airtight materials as beneath the covering the microorganisms find ideal conditions to exist thereby ruining the floor.

Since sufficient ventilation must be allowed, in sections of the installation near the wall wooden strip must be adjusted to allow for ventilation to pass through floor construction, including after the floor is installed. It must be presumed that the existing hollow/space underneath the construction will be constantly dry, to guarantee the balance of moisture of the wooden construction independent of the seasons, and thereby PE film as vapor absorption will not be needed.

[Download Info sheet 6 Underfloor heating](#)

[Download Info sheet 7 CM-Measuring](#)

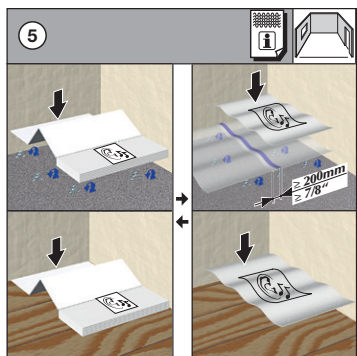

### Subfloor

#### 1. PE Film

A PE film (polyethylene film) or similar of at least 0.2 mm thickness must be laid as a vapor barrier against rising moisture. Allow the PE film to overlap by 20 mm (1") . Glue joints together. Pull the film 4-5 cm (1 1/2 - 2") up the wall.

[Download Info sheet 1 PE Foil](#)

#### 2. Impact Sound Insulation

Apart from the acoustic properties, the impact sound insulation system must have a sufficient **C**ompressive **S**trength. Requirement: CS ≥ 90 kPa ± 9to / m<sup>2</sup>

We recommend products made of the material XPS (extruded polystyrene hard foam). A combination of impact sound and vapor barrier can also be used.

The high-quality Kaindl Sound System pad 2.2 is perfectly matched to your new floor. It has a vapor barrier, anti-microbial and impact sound in one.

[Download Info sheet 2 2 Sound System 2.2mm](#)

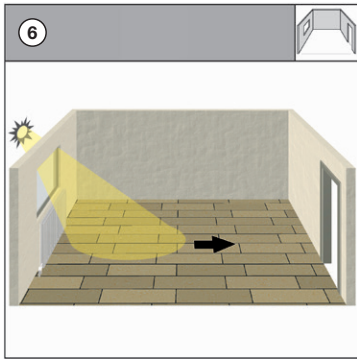

### Laying Direction

Recommended installation direction is lengthwise to the main light source. Flooring consists of several individual boards. The single planks can always be seen in strong light. The joints are more visible crosswise than lengthwise to the light source. Because of the panel format there are less joints in the length than in the width. This is only recommended because there are also other circumstances that may influence the laying direction of the flooring.

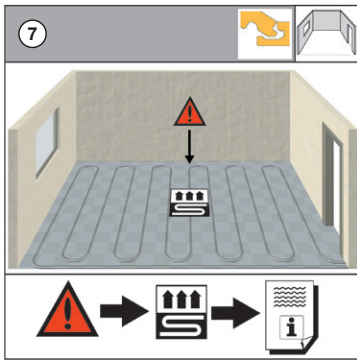

### Installation in conjunction with underfloor heating

Kaindl laminate flooring can be installed trouble-free in conjunction with hot water underfloor heating systems. In Case that Kaindl laminate flooring should be installed in conjunction with electric underfloor heating. Please also see the information sheet on underfloor heating.

[Download Info sheet 6 Underfloor heating](#)

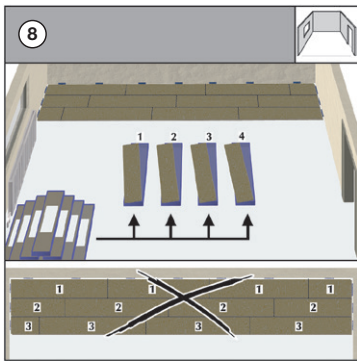

### Panel mixing

Prepare at least 4 packs of flooring. Mix panels from different packs during installation. We recommend alternate fitting of the panels from four different packs at the same time. Keep alternating the panels across the entire floor area. This guarantees the best possible appearance of your Kaindl flooring product.

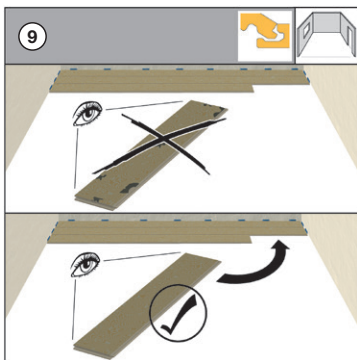

### Check for defective panels

Always carefully inspect the panels for damage before installation. Check for Color correctness, décor accuracy damaged edges or locking profile, or any small damages or possible visual imperfections on the surface. Panels with minor damage can be used in situations where the panels have to be cut. The installation should be done using daylight or equivalent good lighting, as it is possible that small damages may not be recognized in poor lighting. No claims can be accepted in the case of panels which have already been used.

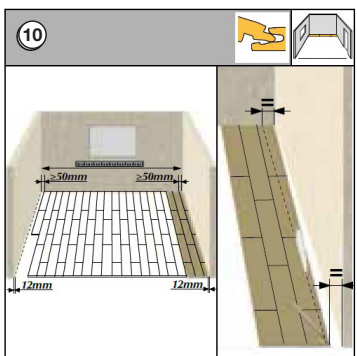

### First panel row parallel towards the wall

Please insure a minimum of > 50 mm (> 2'') width of the first and last row.

The panels must follow the course of the wall; unevenness 5 mm (1/5'') must be marked on the first row of panels using a spacer. The panels have to be sawn lengthways following the marking. The last row of panels at the opposite wall should not be less than 5 cm (2'') wide, if so, the width of the first row of panels should be cut down lengthways to avoid this. Please make sure that there is a minimum distance to the wall of 12 mm (1/2''). Bear this in mind when calculating the last row.



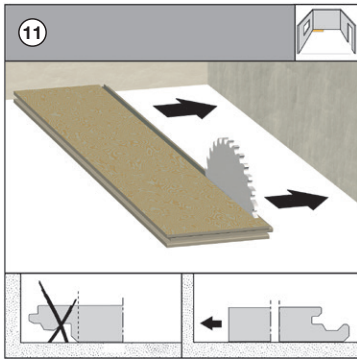

### Installation start

Remove the tongue of the first panel row and lay it against the wall.

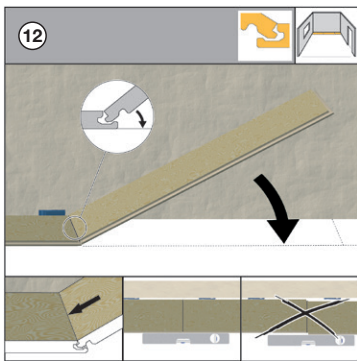

### First row

Insert the panel at an angle of approx. 25° degrees and lower the panel to lock into place. Connect the panels of the first row on the short side. Insert the panel into the groove of the first panel at an angle of 25° degrees; and lower the panel to lock it into place. Ensure that the row is straight. Please see also in the installation video.

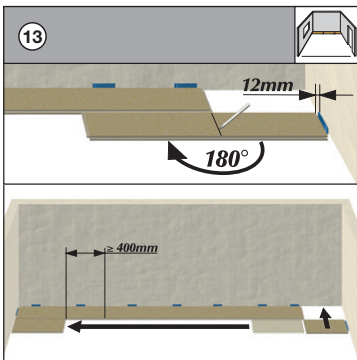

### Offset installation

Mark length, of last panel in each row to allow for minimum offset to the following rows. For accurate cutting of the last panel in the row, rotate the panel 180° degrees; and with the pattern side upwards, place beside the already installed row. Allow for distance from wall at end of panel. Mark out offcut and saw off. Always saw from the upper surface of the panel (to avoid splintering the edges) only when using an electric jig saw or a hand-held circular saw should the patterned side be placed facing downwards. Start each row with the left-over piece from the preceding row. The short-end joints must be set in an appropriate offset (minimum 16"). Because of the offset there is stability in the llaying.

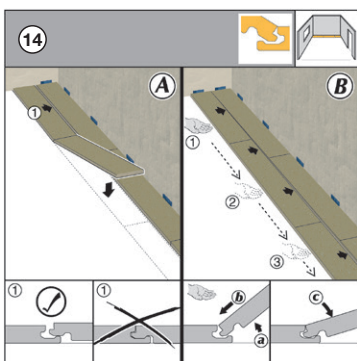

### Sequential panel rows

A) Connect the panels of the second row on the short side only over the entire room length. Thereby place them only on top of the bottom lip from the groove of the panels of the first row without finally connecting them.  
B) Now start to lock lengthwise the second row from left to right.

- To do this:
- Lifting the panels at a 25 degree angle
  - Insert the tongue into the groove
  - Fold the panels down. Do this over the entire length

Place the first panel of the second row exactly on the top of the bottom lip from the groove of the panels of the first row. Without finally connecting them.

Insert the second panel on the long side and lower it down. Use the first row as the guide line. Continue this over the entire room length. Now you have two rows which are tightly locked on the short ends. Lengthwise they are only placed on the top of the bottom lip from the groove of the panels of the first row. Now close the length-side from the left to the right (like zipper) by lifting the panels and close the tongue and groove system by inserting the tongue into the groove and folding down.

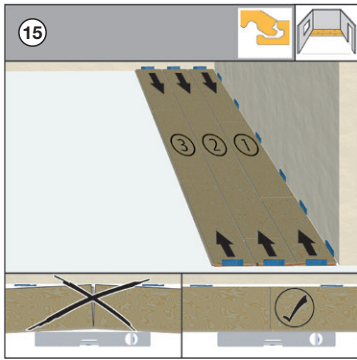

### Fixing towards the wall

Fix towards the walls by using spacers to achieve exact leveling of the rows. Install the first 3 Panel rows before putting them in the final position. This guarantees you a tight connection between the elements. After exact positioning, fix the rows with spacers towards the walls. This protects the rows against moving.

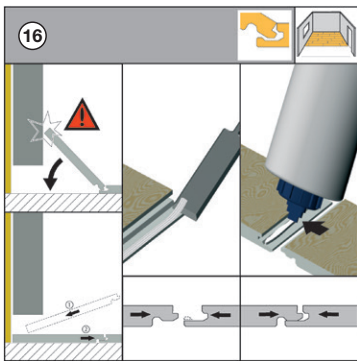

### No possibility to angle the panels

Special cases: If you are not able to angle the panels (e.g. under a door frame or low fitted radiator) you have to cut away the locking edge of lip of the bottom groove by using a wood chisel or a small block plane. Run a bead of glue on the modified tongue and groove. Tap the panels tight together by using a hammer and push block or pull-bar. If necessary, affix it with an adhesive tape.

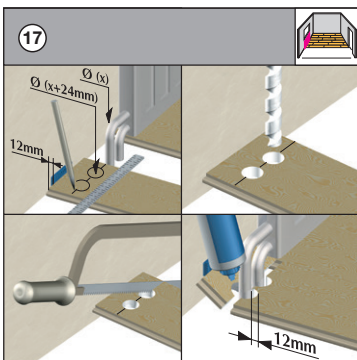

### Installation towards heating pipes (Minimum distance 12 mm (1/2))

Position the panel row so that a transverse joint coincides with the pipe. Join up the sawn off piece again tightly behind the heating pipe (using the spacer). Position the panel row so that a transverse joint coincides with the pipe. First cut the panel to the correct length. Then lay the panel section beside the actual position, measure the recesses with the ruler and draw in.

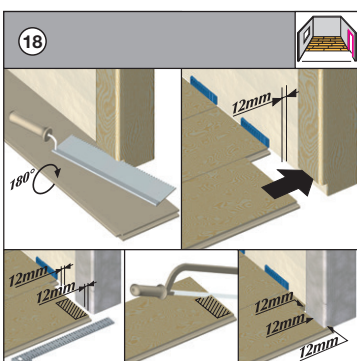

### Installation towards wooden door frames

Minimum distance 12 mm (1/2") Lay a panel next to the door frame (with the patterned side facing downwards) Cut into the door frame with the straight back saw. Then slide the panel under the frame with the patterned side upwards Don't forget to allow for freedom of movement here too 12 mm (1/2").

### Installation towards metal door frames

Minimum distance 12 mm (1/2") Lay a panel next to the door frame (with the patterned side facing downwards) Cut into the door frame with the straight back saw. Then slide the panel under the frame with the patterned side upwards Don't forget to allow for expansion space of minimum 12 mm (1/2").

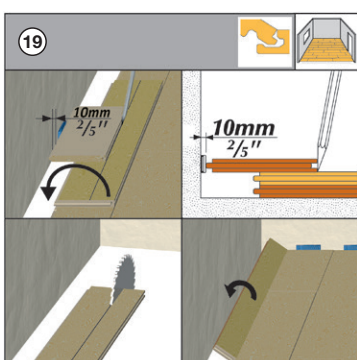

### The final panel row

Lay a panel exactly on the previous row. Lay a second panel (original width) on the top of it and draw an exact line for cutting. Cut away excess wood. Join the panel lengthways. Minimum expansion gap 1.5 mm/lm (1/16" on 3') of 12mm (1/2"). Insert the panel lengthways and lower down.

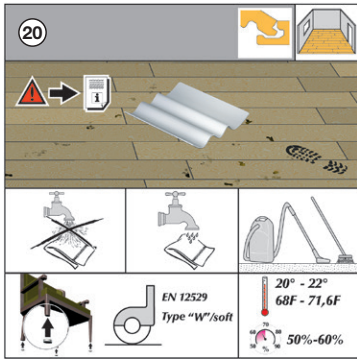

### Care

No wet cleaning. Use felt protectors for furniture feet. Maintain optimum room climate.

The Kaindl laminate floor is very hygienic and easy to care for. Please, however, give the following rules your attention: For daily care, sweeping or vacuuming will suffice. Footprints and dirt can easily be removed with damp cloth. Please use a well-wrung out; damp cloth. Under no circumstances should the floor be cleaned with a wet cloth or mop or be soaked with liquid.

Hardened glue-residue can be removed with acetone or a special glue solvent or usual household cleaners may be used, please avoid scouring agents, wax or polish. For regular cleaning and preservation we recommend Kaindl-Floor Cleaner. Larger soiling and persistent stains like color, glue, nail varnish or oil can easily be removed using acetone or any other alcohol containing solvents.

### Maintenance

Put flower pots on water resistant mats. Furniture legs ought to be fitted with felt gliding pad. Rolling furniture should have soft rubber rollers (type W) in accordance with DIN 12529.

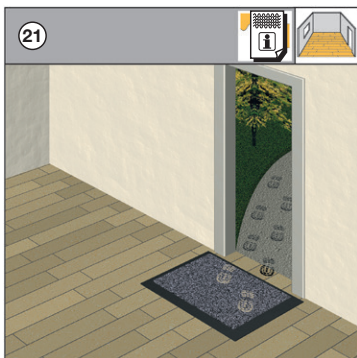

### Prevent dirt ingress

Please place in areas exposed to mud e.g. the entrance dirt traps or mats. Cleaning zones must be installed in commercial use areas. Minimum length 4m (13,12').

Dirt absorbing mats ensure that only an average amount of dirt comes on the floor. Dirt ingress e.g. fine minerals (little stones) damage your floor because they work like sand paper.

[Download Info sheet 11 Value Retention and care](#)

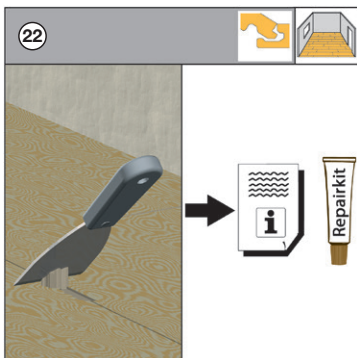

### Repair of small damages

Should minor damages such as cracks or indentations occur, you can take care of it yourself with a color coordinated repair-set.

This won't reduce the quality of the floor. Greater damage, however, should be repaired by a trained professional.